

TOP VIEW
1:50

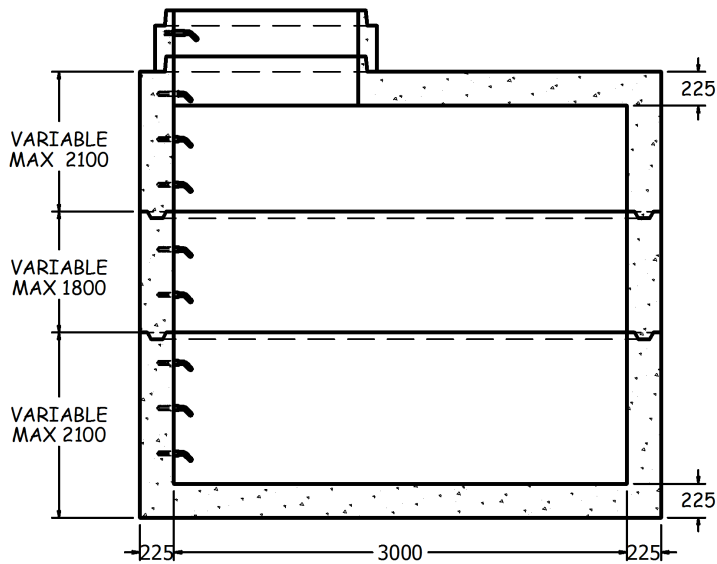

SECTION A-A
1:50

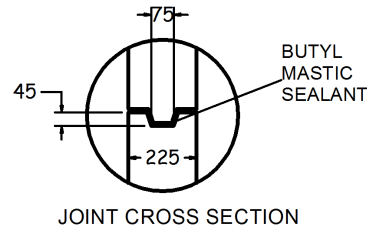
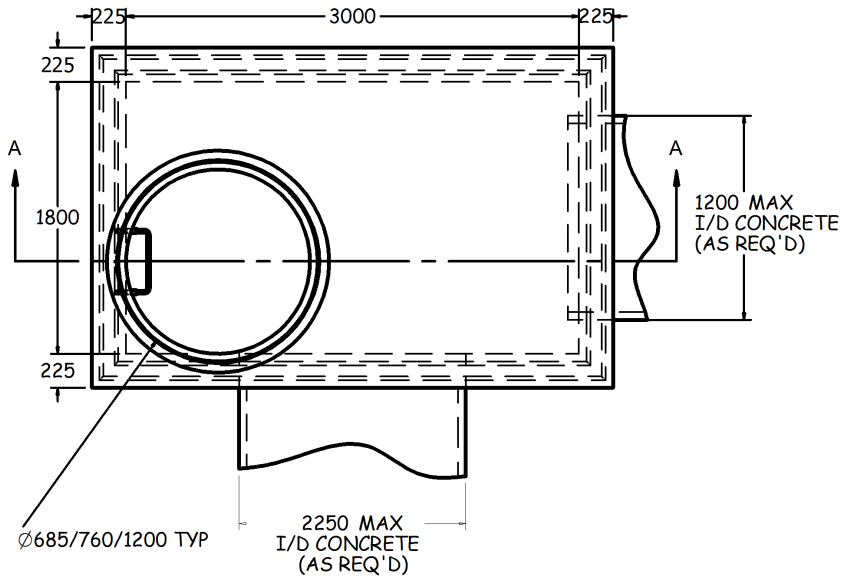
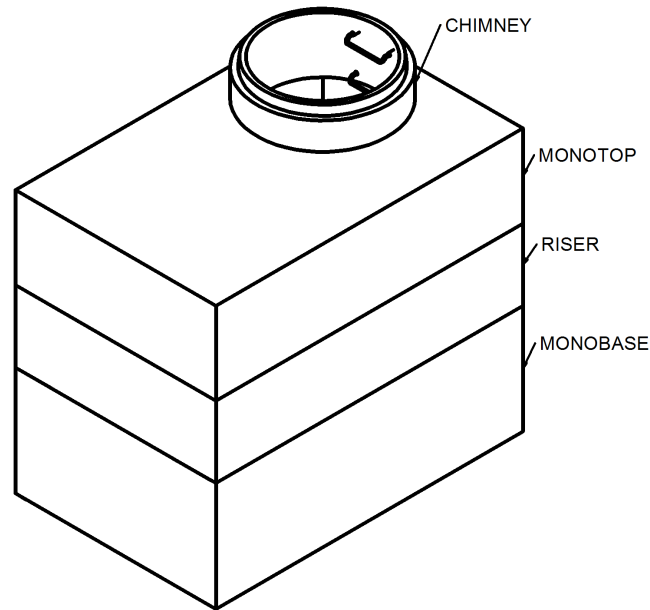

ISOMETRIC VIEW
1:60

SPECIFICATIONS

ALL DIMENSIONS IN MILLIMETRES.

CONCRETE:

45 MPa @ 28 DAYS,
5-8% AIR ENTRAINMENT IN ACCORDANCE
WITH CSA A23.1 MOD-M90.

REINFORCING:

IN ACCORDANCE WITH CSA G30.18 & OPSS 1440.
ALL REINFORCING STEEL HAS 30mm MIN. COVER.

WEIGHT:

WALLS	-5670 KG/V.M.
MONOBASE/TOP	-2916 KG
TOP SLAB	-4192 KG

NOTES:

PRODUCT MANUFACTURED TO OBC & C.H.B.D.C.
LOADINGS AS APPLICABLE.

MANUFACTURED IN ACCORDANCE WITH OPSS 1351.

REINFORCING DETAILS AVAILABLE UPON REQUEST.

ALL PIECES INCLUDE SWIFT LIFT LIFTING ANCHORS.

ALL MAINTENANCE HOLES INCLUDE
HOLLOW ALUMINUM LADDER RUNGS
AS PER OPSD 405.010.

SUMP AVAILABLE UPON REQUEST.

VARIABLE OPENINGS IN TOP SLAB
AVAILABLE UPON REQUEST.

MAX. BURIAL DEPTH: 900mm.
DEEP BURIAL DEPTHS AVAILABLE UPON REQUEST.

REFER TO DRAWING MH-3 FOR MAX. PIPE SIZES.
PIPE GASKETS AVAILABLE UPON REQUEST.

REFER TO INSTALLATION GUIDELINES
FOR BOX MANHOLES AND CHAMBERS.

1800x3000 BOX MANHOLE (BM1800)



1645 SYDENHAM RD.
KINGSTON, ONT.

PHONE:
(800) 223-0012
1-613-546-6683

www.anchorconcrete.com