

INSIDE DIA.

MAXIMUM PIPE SIZE FOR
STRAIGHT THROUGH
INSTALLATION

MAXIMUM PIPE SIZE FOR
RIGHT ANGLE
INSTALLATION

1220mm

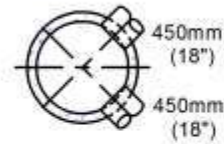
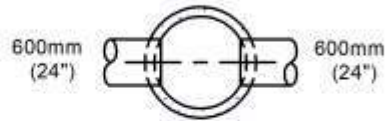

1520mm

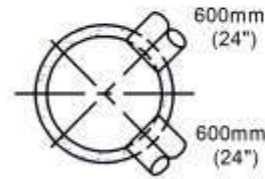
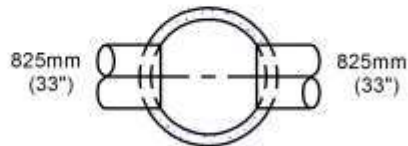

1830mm

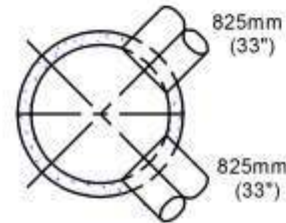
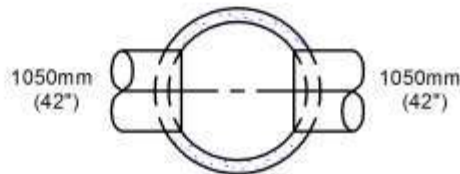

2400mm

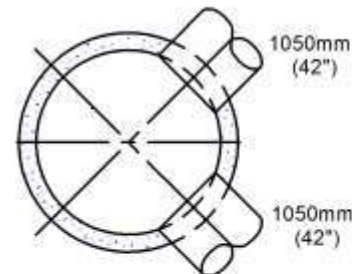
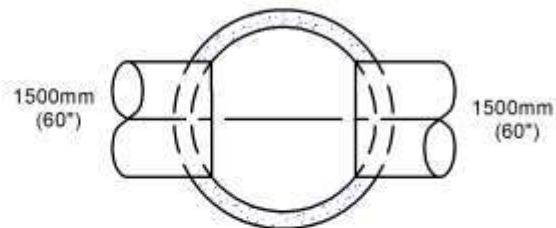

3000mm

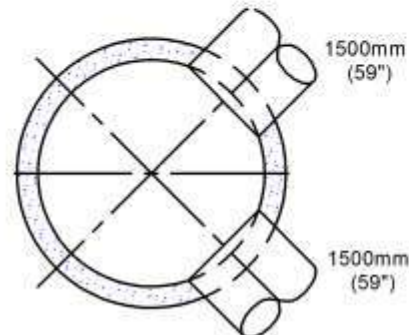
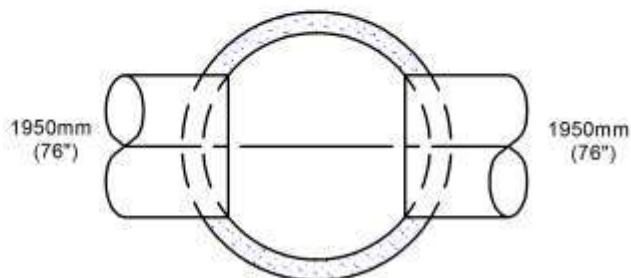

MAXIMUM CONCRETE PIPE SIZES FOR CYLINDRICAL MANHOLES

KNOCKOUTS FOR 250mm OR 300mm
CATCHBASIN LEADS
COULD BE PROVIDED IN ADDITION
TO WHAT IS SHOWN.

SCALE 1:100



1645 SYDENHAM RD.
KINGSTON, ONT.

PHONE:
(800) 223-0012
1-613-546-6683

www.anchorconcrete.com