

**OPTIONS AVAILABLE UPON REQUEST INCLUDE:**

- DUCT TERMINATORS
- SUMP W/DRAIN
- CAST-IN PULLING EYES
- CAST-IN CABLE RACKS
- CAST IRON EMBOSSED W/ ELECTRICAL OR COMMUNICATION

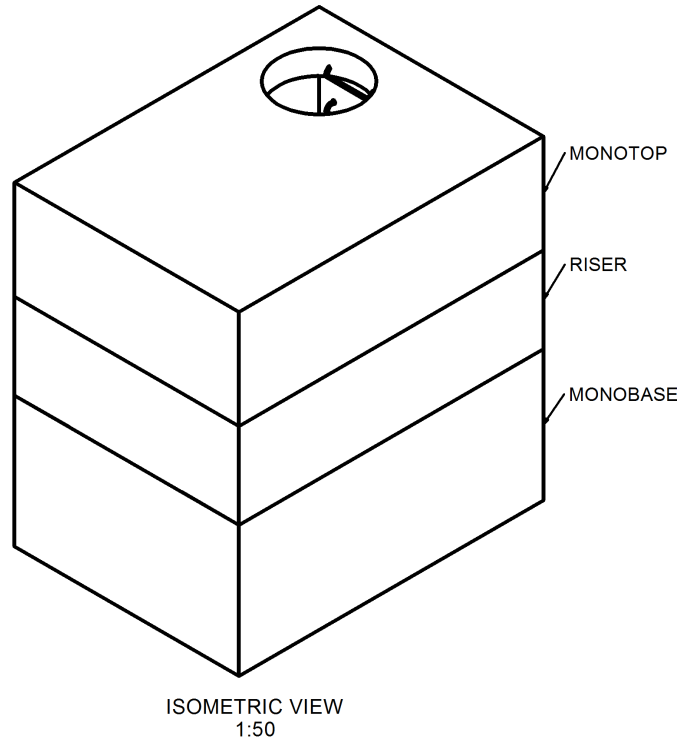
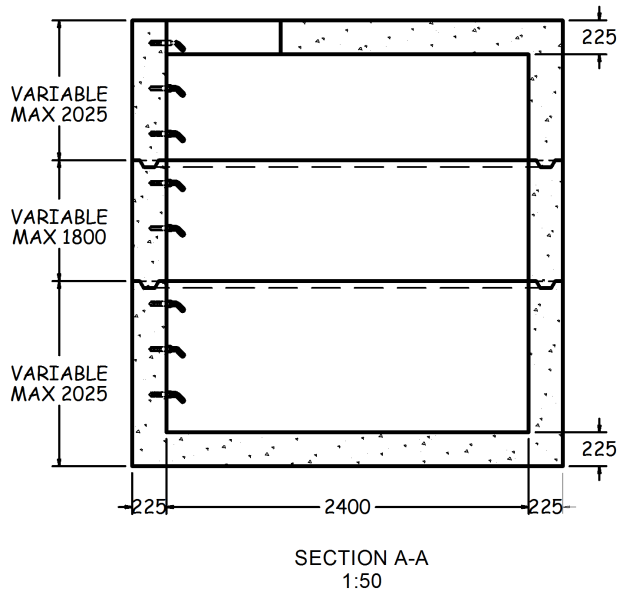
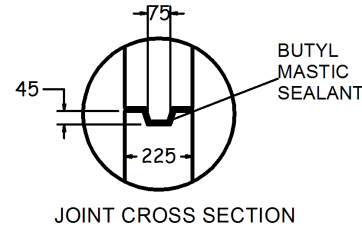
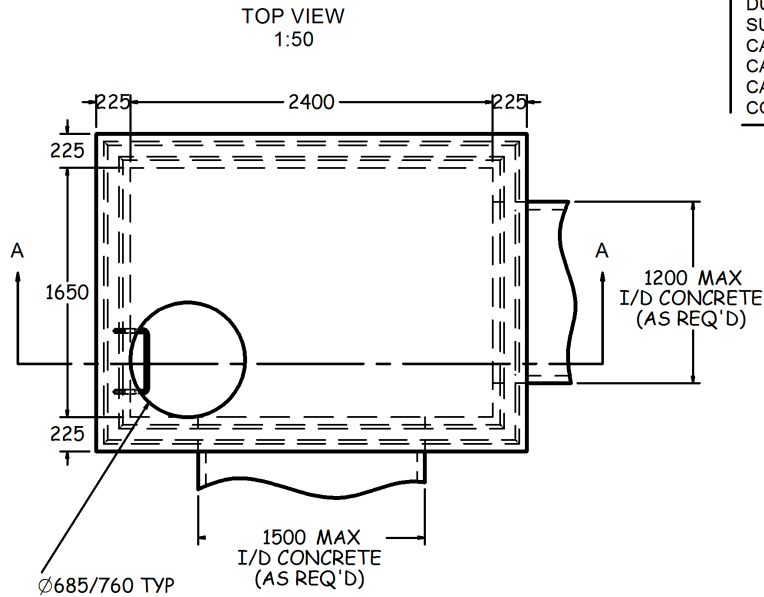

**1650x2400 ELECTRICAL/COMMUNICATION MANHOLE (BM1650)**

**SPECIFICATIONS**

ALL DIMENSIONS IN MILLIMETRES.

**CONCRETE:**

45 MPa @ 28 DAYS,  
5-8% AIR ENTRAINMENT IN ACCORDANCE  
WITH CSA A23.1 MOD-M90.

**REINFORCING:**

IN ACCORDANCE WITH CSA G30.18 & OPSS 1440.  
ALL REINFORCING STEEL HAS 30mm MIN. COVER.

**WEIGHT:**

WALLS	-4860 KG/V.M.
MONO BASE/TOP	-2138 KG
TOP SLAB	-3033 KG

**NOTES:**

- PRODUCT MANUFACTURED TO C.H.B.D.C. LOADING.
- MANUFACTURED IN ACCORDANCE WITH OPSS 1351.
- REINFORCING DETAILS AVAILABLE UPON REQUEST.
- ALL PIECES INCLUDE SWIFT LIFT LIFTING ANCHORS.

ALL MAINTENANCE HOLES INCLUDE  
SOLID ALUMINUM LADDER RUNGS  
AS PER OPSD 405.020.

VARIABLE OPENINGS IN TOP SLAB  
AVAILABLE UPON REQUEST.

MAX. BURIAL DEPTH: 900mm.  
DEEP BURIAL DEPTHS AVAILABLE UPON REQUEST.

REFER TO DRAWING MH-3 FOR MAX. PIPE SIZES.  
PIPE GASKETS AVAILABLE UPON REQUEST.

REFER TO INSTALLATION GUIDELINES  
FOR BOX MANHOLES AND CHAMBERS.



1645 SYDENHAM RD.  
KINGSTON, ONT.

PHONE:  
(800) 223-0012  
1-613-546-6683

[www.anchorconcrete.com](http://www.anchorconcrete.com)