

NOTES:

ALL DIMENSIONS IN MILLIMETERS UNLESS OTHERWISE SPECIFIED.

NOT TO SCALE

ARCHITECTURAL FINISHES AVAILABLE UPON REQUEST

RETAIN A LICENSED PROFESSIONAL ENGINEER TO DESIGN EVERY RETAINING WALL ON A CASE-BY-CASE BASIS.

ALL LIFTING ANCHORS ARE TO BE DAYTON SUPERIOR OR APPROVED ALTERNATIVE. ALL RIGGING, HOISTING, AND LIFTING TO BE IN STRICT ACCORDANCE WITH DAYTON SUPERIOR MANUAL.

**1/3 ANCHOR RISER BLOCK
1200kg**

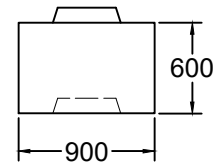
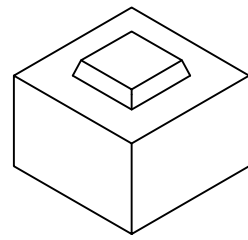

SIDE VIEW

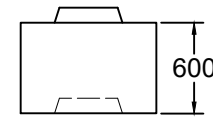

FRONT VIEW

**1/3 ANCHOR TOP BLOCK
1200kg**

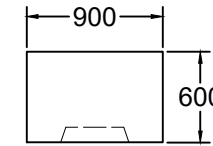
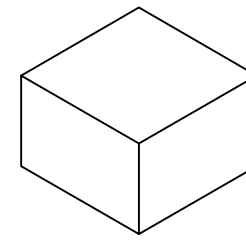

SIDE VIEW

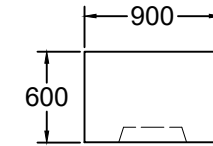

FRONT VIEW

**2/3 ANCHOR RISER BLOCK
2300kg**

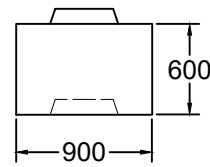
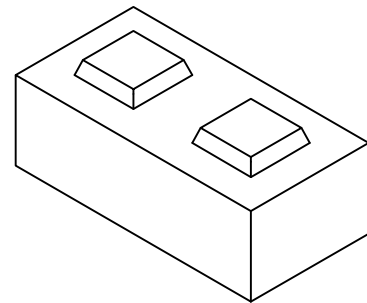

SIDE VIEW

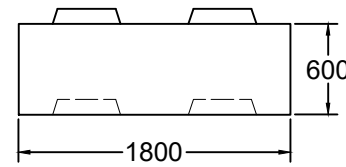

FRONT VIEW

**2/3 ANCHOR TOP BLOCK
2300kg**

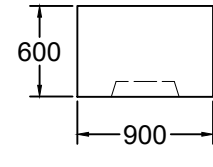
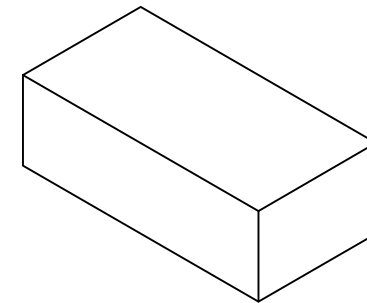

SIDE VIEW

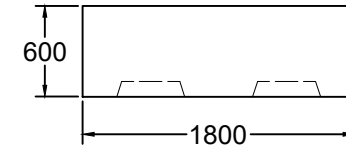

FRONT VIEW

**FULL SIZE ANCHOR RISER BLOCK
3500kg**

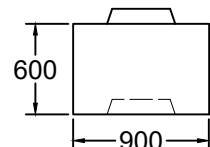
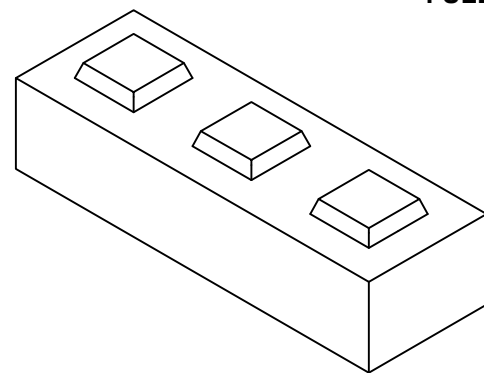

SIDE VIEW

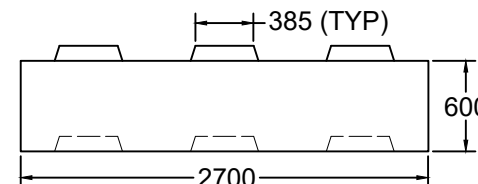

FRONT VIEW

**FULL SIZE ANCHOR TOP BLOCK
3500kg**

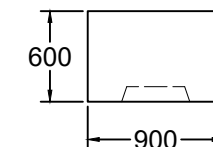
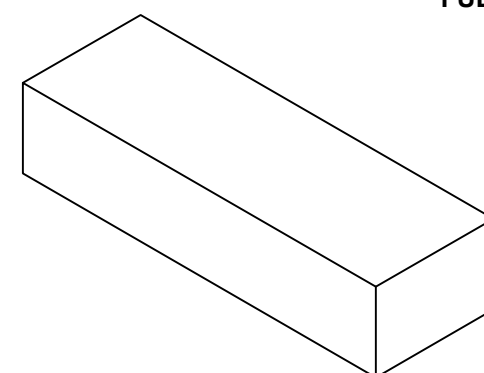

SIDE VIEW

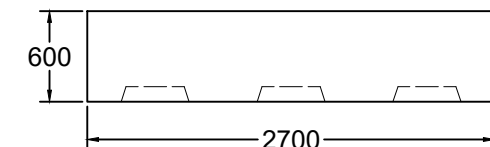

FRONT VIEW

SPECIFICATIONS:
PRODUCT DESIGNED IN ACCORDANCE WITH CSA A23.3

PRODUCTION:
IN ACCORDANCE WITH CSA A23.4

CONCRETE:
IN ACCORDANCE WITH CSA A23.1
EXPOSURE CLASS: C1, 28 DAY COMP. STRENGTH: 35MPA, AIR ENTRAINMENT 5-8%

ANCHOR BLOCK RETAINING WALL SYSTEM

DRAWN BY:

JS

DATE:

AUG 2023



1645 SYDENHAM RD.
KINGSTON, ON

PHONE:
(800) 223-0012
1-613-546-6683

WWW.ANCHORCONCRETE.COM